

BRC3108

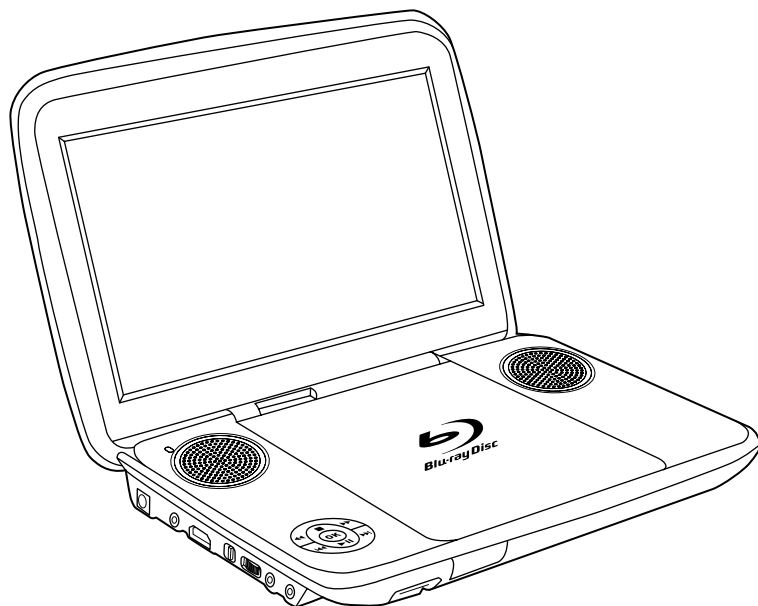

IMPROVE YOUR PRODUCT!

Blu-ray technology is constantly changing and improving. To ensure you're getting the best performance from your product, **please visit our website to download the latest operating software for it.**

Simply go to **www.RCAav.com**, click on your product's link and you'll get the latest operating software.

Just follow the online instructions and you'll have your product upgraded in minutes!

Important Information



The lightning flash with an arrowhead symbol, within the equilateral triangle, is intended to alert the user to the presence of uninsulated "dangerous voltage" within the product's enclosure that may be of sufficient magnitude to cause an electric shock.



The exclamation point within the equilateral triangle is intended to alert the user to the presence of important operating and maintenance (servicing) instructions in this owner's manual.

**** SEE BOTTOM OF APPARATUS FOR GRAPHIC SYMBOLS ****



This product contains a low power laser device.

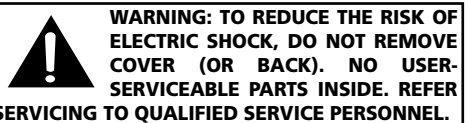

WARNING: TO PREVENT FIRE OR SHOCK HAZARD, DO NOT EXPOSE THIS APPLIANCE TO RAIN OR MOISTURE. DO NOT PLACE OBJECTS FILLED WITH LIQUIDS ON OR NEAR THIS UNIT.

CAUTION: USE OF CONTROLS OR ADJUSTMENTS OR PERFORMANCE OF PROCEDURES OTHER THAN THOSE SPECIFIED MAY RESULT IN HAZARDOUS RADIATION EXPOSURE.

CAUTION: DANGER OF EXPLOSION IF BATTERY IS INCORRECTLY REPLACED. REPLACE ONLY WITH THE SAME OR EQUIVALENT TYPE.



On Placement

- Do not use the unit in places that are extremely hot, cold, dusty, or humid.
- The ventilation should not be impeded by covering the ventilation openings with items such as newspaper, table-cloths, curtains, etc.

On Safety

- When connecting or disconnecting the AC power adapter, grip the plug and not the cord itself. Pulling the cord may damage it and create a hazard.
- When you are not going to use the unit for a long period of time, disconnect the AC power adapter.
- No naked flame sources such as lighted candles should be placed on the AC power adapter and the unit.
- Leave a minimum of 10cm around the apparatus for ventilation.
- Attention should be drawn to the environmental aspects of battery disposal.
- Use of apparatus in moderate climates.

On Condensation

- When left in a heated room where it is warm and damp, water droplets or condensation may form inside the unit. When there is condensation inside the unit, the unit may not function normally. Let the unit stand for 1 to 2 hours before turning the power on, or gradually heat the room and let the

unit dry before use.

Rating Plate Location

- The rating plate is located at the bottom of apparatus.

FCC Statements

NOTE: This equipment has been tested and found to comply with the limits for a Class B digital device, pursuant to Part 15 of the FCC Rules. These limits are designed to provide reasonable protection against harmful interference in a residential installation. This equipment generates, uses and can radiate radio frequency energy and, if not installed and used in accordance with the instructions, may cause harmful interference to radio communications. However, there is no guarantee that interference will not occur in a particular installation. If this equipment does cause harmful interference to radio or television reception, which can be determined by turning the equipment off and on, the user is encouraged to try to correct the interference by one or more of the following measures:

- Reorient or relocate the receiving antenna.
- Increase the separation between the equipment and receiver.
- Connect the equipment into an outlet on a circuit different from that to which the receiver is connected.
- Consult the dealer or an experienced radio/TV technician for help.

Warning: Changes or modifications to this unit not expressly approved by the party responsible for compliance could void the user's authority to operate the equipment.

Notes on Copyright

It is forbidden by law to copy, broadcast, show, broadcast on cable, play in public, or rent copyrighted material without permission.

This item incorporates copy protection technology that is protected by U.S. patents and other intellectual property rights of Rovi Corporation. Reverse engineering and disassembly are prohibited.

THIS CLASS B DIGITAL APPARATUS COMPLIES WITH CANADIAN ICES-003.



- **THE APPARATUS SHALL NOT BE EXPOSED TO DRIPPING OR SPLASHING AND THAT NO OBJECTS FILLED WITH LIQUIDS, SUCH AS VASES, SHALL BE PLACED ON APPARATUS.**
- **TO PREVENT FIRE OR SHOCK HAZARD, DO NOT EXPOSE THIS UNIT TO RAIN OR MOISTURE. DO NOT PLACE OBJECTS FILLED WITH LIQUIDS ON OR NEAR THIS UNIT.**
- **SHOULD ANY TROUBLE OCCUR, DISCONNECT THE AC POWER ADAPTER AND REFER SERVICING TO A QUALIFIED TECHNICIAN.**
- **AC/DC ADAPTER IS USED AS DISCONNECT DEVICE. TO BE COMPLETELY DISCONNECTED FROM THE POWER INPUT, THE UNIT'S AC ADAPTER SHOULD BE DISCONNECTED FROM THE WALL OUTLET. THE AC ADAPTER SHOULD NOT BE OBSTRUCTED AND SHOULD BE EASILY ACCESSIBLE DURING INTENDED USED.**

Important Safety Instructions

1. Read these instructions.
2. Keep these instructions.
3. Heed all warnings.
4. Follow all instructions.
5. Do not use this apparatus near water.
6. Clean only with a dry cloth.
7. Do not block any of the ventilation openings. Install in accordance with the manufacturer's instructions.
8. Do not install near any heat sources such as radiators, heat registers, stoves, or other apparatus (including amplifiers) that produce heat.
9. Do not defeat the safety purpose of the polarized or grounding - type plug. A polarized plug has two blades with one wider than the other. A grounding type plug has two blades and a third grounding prong. The wide blade or the third prong is provided for your safety. If the provided plug does not fit into your wall outlet, consult an electrician for replacement of the obsolete outlet.
10. Protect the power cord from being walked on or pinched particularly at plugs, convenience receptacles, and the point where they exit from the apparatus.
11. Only use attachments/accessories specified by the manufacturer.
12. Use only with a cart, stand, tripod, bracket, or table specified by the manufacturer, or sold with the apparatus. When a cart is used, use caution when moving the cart/apparatus combination to avoid injury from tip-over.
13. Unplug this apparatus during lightning storms or when unused for long periods of time.
14. Refer all servicing to qualified service personnel. Servicing is required when the apparatus has been damaged in any way, such as the power-supply cord or plug is damaged, liquid has spilled or objects have fallen into the apparatus, the apparatus has been exposed to rain or moisture, does not operate normally, or has been dropped.



Table of Contents

Disc Formats.....	1	Audio Selection	12
Accessories.....	2	Subtitle Selection	12
Remote Control.....	2	Angle Selection	12
Control Reference Guide	3	Using the PiP (Picture-in-picture) mode .	13
Remote Control.....	3	Using a Disc Pop Up Menu	13
Player	4	Displaying Blu-ray Disc Information	13
Power Supply.....	5	Using the Picture Menu	13
Using the Car Power Adapter	5	Locating a Desired Section	14
Using the AC power Adapter	5	Locating a specific chapter	14
Using the Built-in Battery	6	Locating a specific title	14
Connections.....	7	Locating a specific time	14
Connecting to a TV	7	Playing Picture Files.....	14
Connecting an Audio Receiver.....	7	Repeat Playback	15
Using USB port	8	Customizing the Function	
Using Headphones/Earphones	8	Settings	16
Ethernet Jack - Connecting to a Home		Language Setup	16
Network.....	8	Video Setup	16
Mounting in a Vehicle	9	General Setup.....	17
Sound System	9	Maintenance.....	18
Unit Operation	10	Troubleshooting Guide	19
Playing a Blu-ray Disc or DVD	11	Limited Warranty	20
Pausing Playback (still mode)	11		
Stopping Playback.....	11		
Skipping to a different track.....	11		
Fast Forward / Fast Reverse	11		

Disc Formats

This player can playback discs bearing any of the following marks:



DVDs
[8cm(3")/12cm(5") disc]





Blu-ray Discs
[8cm(3")/12cm(5") disc]



Audio CDs
[8cm(3")/12cm(5") disc]

CD-R CD-RW
Compatible

Region Management Information





This unit has been designed to playback BD-video with region  and DVD-video with region . You cannot playback BD-video or DVD-video that are labeled for other regions. Look for the symbols on the right on your BD-video or DVD-video. If these region symbols do not appear on your BD-video or DVD-video, you cannot playback the disc in this unit.

Disc Function or Operation that is Not Available

When the  symbol appears on the screen, it indicates that the function or operation attempted is not available at that time. This occurs because the disc manufacturer determines the specific functions. Certain functions may not be available on some discs. Be sure to read the documentation provided with the disc.

Icons Used on DVDs

Sample Icons

	1. English 2. French	—Language selections for audio
	1. English 2. French	—Language selections for subtitles
		—Screen aspect ratio
		—Multiple camera angles
		—Region code indicator

Note:

- When playing back a CD-G (Graphics) or CD EXTRA disc, the audio portion will be played, but the graphic images will not be shown.

Titles, Chapters and Tracks

- Blu-ray Discs and DVDs are divided into "titles" and "chapters". If the disc has more than one movie on it, each movie would be a separate "title". "Chapters" are sections of titles.
- Audio CDs are divided into "tracks". A "track" is usually one song on an Audio CD.

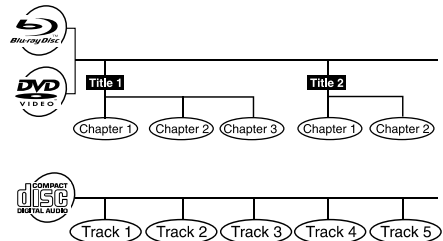

Note:

- Numbers identify each title, chapter, and track on a disc. Most discs have these numbers recorded on them, but some do not.

Notes on Unauthorized Discs

You may not be able to play back some discs on this unit if they were purchased from outside your geographic area or made for business purposes.

Accessories

Please check and identify the supplied accessories.

- Remote Control (with batteries)x 1
- Car Power Adapter.....x 1
- AC Power Adapterx 1
- Carrying Bagx 1
- AV Cablex 1

Remote Control

Using the Remote Control

- Point the remote control at the REMOTE SENSOR located on the unit.
- When using this unit in very bright light, the infrared REMOTE CONTROL SENSOR may not work properly.
- The recommended effective distance for remote operation is about 16 feet (5 meters).

Battery Replacement

When the batteries become weak, the operating distance of the remote control will be greatly reduced and you will need to replace the batteries.

To Change Remote Batteries

1. Open the battery door.

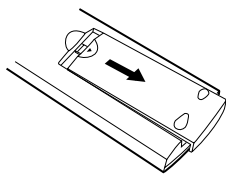

2. Insert two AAA size batteries.

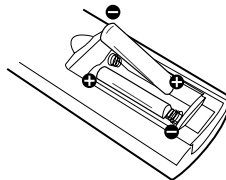

Note:

- If the remote control is not going to be used for a long time, remove the batteries to avoid damage caused by battery leakage corrosion.
- When discarding batteries, environmental problems must be considered and local rules or laws governing the disposal of these batteries must be strictly followed.
- Do not mix old and new batteries. Do not mix ALKALINE, standard (CARBON-ZINC), or rechargeable (Ni-Cd, Ni-MH, etc) batteries.

WARNING:

- Do not dispose of the battery in fire or it may explode or leak.
- Batteries shall not be exposed to excessive heat such as sunshine, fire or the like.

CAUTION:

Danger of explosion if battery is incorrectly replaced. Replace only with the same or equivalent type.

Control Reference Guide

Remote Control

1. **PICTURE Button**
Press to adjust brightness, contrast, backlight & Screen.
2. **Number (0-9) Buttons**
3. **CLEAR Button**
Clear input selections and cancel certain playback functions.
4. **Color buttons**
When playing a Blu-ray Disc that has a Java application, press to control playback. For more information, see the documentation that comes with the Blu-ray Disc.
5. **MENU Button**
Press to open or close the Disc's menu.
6. **◀ / ▶ Buttons**
Fast reverse or fast forward playback.
7. **POP UP Button**
During Blu-ray Disc playback, press to open a menu that lets you control Blu-ray Disc playback.
During DVD playback, press to open the DVD title menu (if available).
8. **SLOW Button**
Press to perform slow forward playback of Blu-ray Discs or DVDs.
9. **■ STOP Button**
Press to stop playback.
10. **CURSOR (▲, ▼, ◀, ▶) Button**
Press to highlight selections on a menu screen and adjust certain settings.
OK Button
Press to confirm selections on a menu screen.
11. **EXIT Button**
12. **SUBTITLE Button**
Press to select one of the subtitle languages programmed on a Blu-ray Disc or DVD.
13. **PI P Button**
Press to turn PiP (picture in picture) mode on or off. This function is only available on certain Blu-ray Discs.
14. **INFO Button**
Accesses the info menu.
15. **A-B REPEAT Button**
Press to perform point-to-point repeat playback on a DVD or CD.
16. **⏻ Button**
Press to turn on the unit or put it in standby mode.
17. **GOTO Button**
Press to skip directly to a specific location on a Blu-ray Disc or DVD.

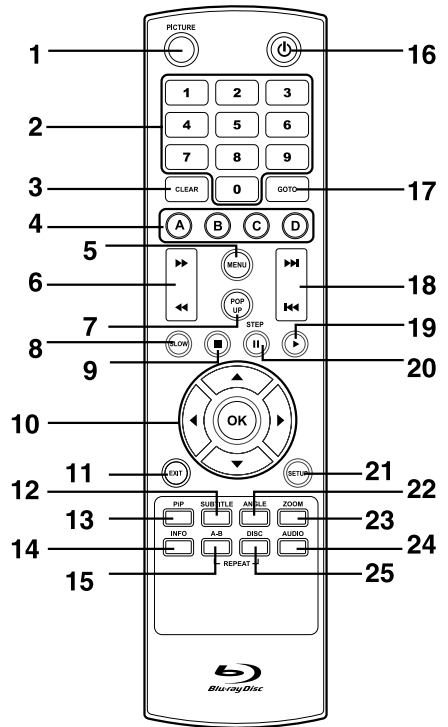

18. **◀ / ▶ Skip Buttons**
Press to move backwards or forward through titles, chapters or tracks on a Blu-ray Disc, DVD or CD.
19. **▶ PLAY Button**
Press to start playback.
20. **|| PAUSE/ STEP Button**
Press to pause playback, frame advance.
21. **SETUP Button**
At stop mode, press to open or close the SETUP menu screen.
22. **ANGLE Button**
Press to switch the camera angle of the video presentation when scenes with multiple camera angles are recorded on a Blu-ray Disc or DVD.
23. **ZOOM Button**
Zoom in an image.
24. **AUDIO Button**
Press to select one of the audio sound tracks programmed on a Blu-ray Disc or DVD.
25. **DISC REPEAT Button**
Press to repeat chapter or title of a Blu-ray Disc or DVD. Press to repeat single track or whole CD.

Control Reference Guide

Player

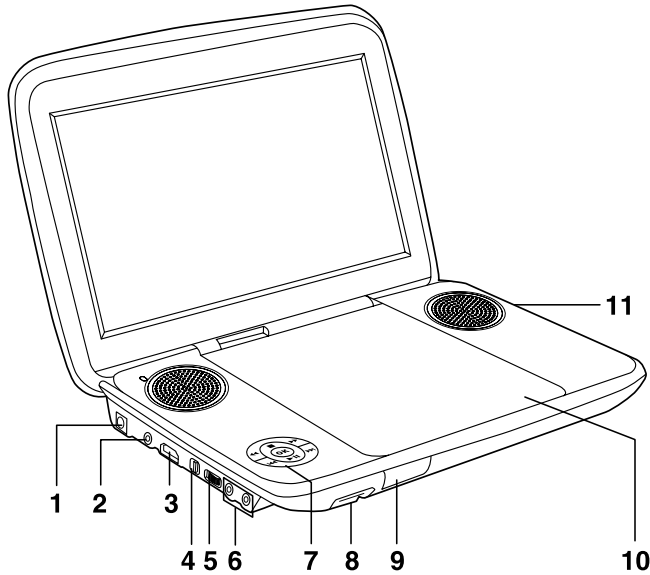

1. DC IN 9V-12V Jack
2. AV OUT Jack
3. HDMI OUT Jack
4. CHARGE / OFF / ON Switch
5. VOLUME Control
Adjusts the volume.
6. Headphone Jacks
7. ◀◀ REV / ▶▶ FWD Buttons
Performs fast reverse / forward playback.
■ Stop Button
Stops playing a disc.
◀◀ / ▶▶ Skip Buttons
Goes backwards to previous chapters/titles/
tracks or advances chapters/titles/tracks.
OK Button
Press to confirm your selections.
▶|| Play / Pause Button
Starts or resumes playback of a disc.
8. USB Port
9.  Indicator
When charging with the AC power adapter,
switch the CHARGE / OFF / ON switch to CHARGE
position, the light will illuminate.
⊕ Indicator
When the CHARGE / OFF / ON switch is in ON
position you can use the remote control to put
the product in STANDBY mode. This light will
illuminate when product is in STANDBY mode.
Remote Sensor
Receives the remote control signal.
10. Push to open and close Disc Door
11. LAN Jack (currently unused - may be operative
on future Product Software Upgrades - please
visit www.RCAav.com for information on
updates).

Power Supply

A. Using the Car Power Adapter

The included 12V car power adapter is designed for use with vehicles that have a 12V, negative ground electrical system.

WARNING:
Disconnect this car power adapter when not in use. Not for use in 24V vehicles.

IMPORTANT
This car adapter is for use with 12 volt batteries only.

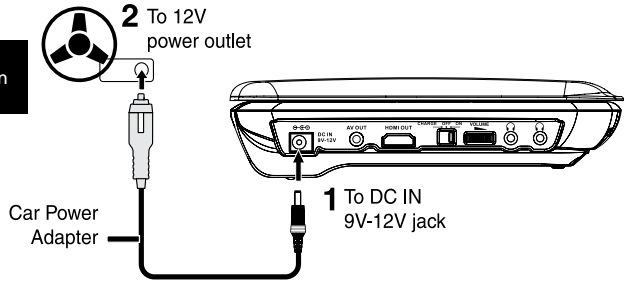

Cautions:

- Use this unit only with the included 12V car power adapter. Use with other car adapters could damage the unit, or even your vehicle.
- The included 12V car power adapter is for use with this unit only. Do not use it with any other equipment.
- In the interest of traffic safety, drivers should not operate the unit or view videos while driving.
- When the inside of the 12V power outlet is dirty with ashes or dust, the plug section may become hot due to poor contact. Be sure to clean the 12V power outlet before use.
- After use, disconnect the 12V car power adapter from both the unit and 12V power outlet.
- If the unit is not properly attached to a vehicle, it may become airborne in the event of an accident and cause damage, injury, or death.
- Check your local traffic laws for rules governing the use of video devices in vehicles.

B. Using the AC power Adapter

The included AC power adapter operates on AC between 100V-240V. It is suitable for use on AC mains supplies of 100-240 Volts AC and should only be connected to a mains supply within these parameters.

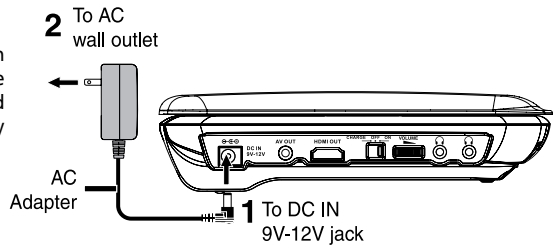

Cautions:

- Turn off the unit before unplugging the AC power adapter to avoid damage to the unit.
- When the unit is not going to be used for a long time, disconnect the AC power adapter from the AC outlet.
- The AC power adapter included with this unit is for its use only. Do not use it with other equipment.

IMPORTANT

- Be sure to use the unit close to the wall outlet and make it is easily accessible. If a malfunction occurs, disconnect the plug from the wall outlet at once.
- When the AC power adapter is plugged in, the apparatus is not completely disconnected from the main power source, even when the unit is turned off.

C. Using the Built-in Battery

The unit has a built-in, non-replaceable, rechargeable battery. Charge the built-in battery before using it for the first time. The normal charging time should be completed within 4-5 hours. The green charging light will go out when the built-in battery becomes fully charged.

To Recharge the Built-in Battery

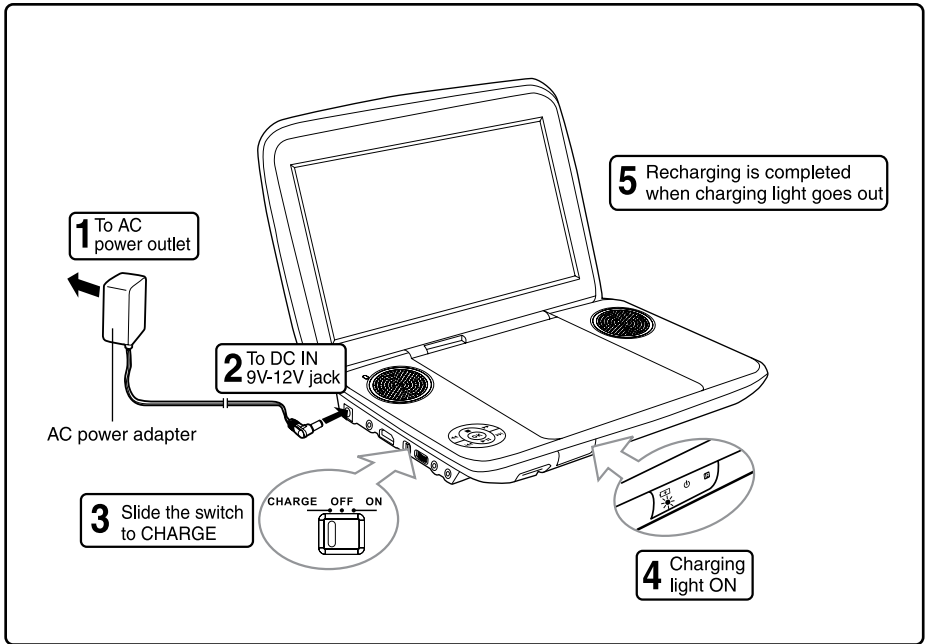

⚠ WARNINGS:

- The built-in battery should not be exposed to excessive heat such as sunshine, fire or the like.
- The built-in battery present a risk of fire or chemical burn if mistreated. Do not disassemble, heat above 212°F (100°C), or incinerate.
- Dispose of the unit with used built-in battery properly, environmental problems must be considered and local rules or laws governing the disposal must be strictly followed.

CAUTIONS:

- The built-in battery can only be recharged when the unit is in CHARGE mode while using the AC adapter.
- The built-in battery cannot be recharged when the unit is in power ON mode.
- Do NOT recharge the battery in the vehicle by using the car power adapter.
- When the built-in battery power is low,  will display on the screen and the unit will stop playing.
- Recharge the built-in battery when you are ready to use it again.
- While using the built-in battery, the environmental temperature should be 41°F (5°C) to 95°F (35°C).
- To get the longest service life of the built-in battery, charge at indoor temperature.

Connections

A. Connecting to a TV

1. Using the supplied AV cable

If your TV has Audio/Video inputs, you can connect the player to your TV using the supplied AV cable.

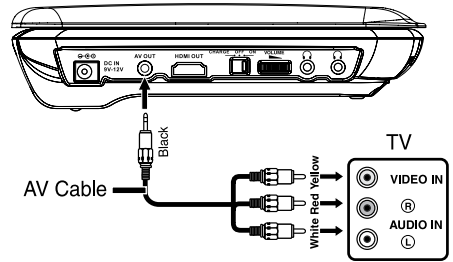

2. Using a HDMI cable (not included)

For TVs that support it, HDMI can provide the best quality audio and video output (depending on media source), and so is the preferred connection type. The HDMI cable incorporates both audio and video signals, so you will have just one cable running from the unit to your TV. Using a HDMI cable (not included), connect the HDMI OUT jack on your unit to the HDMI IN jack on your TV or HDMI-compatible display.

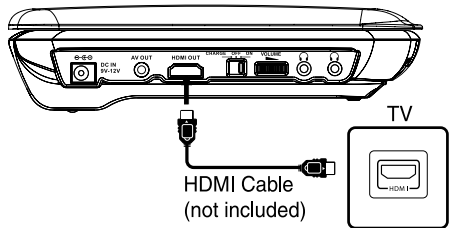

- Configure the Video Setup options (found in the SETUP menu) to best match the capabilities of your TV.
- Set the HDMI resolution to match the capabilities of your TV. This setting is also in the Video Setup section of the SETUP menu. Note: this setting can be selected only when the HDMI cable is connected to a TV.

Note:

- Refer to your TV owner's manual as well.
- When you connect the player to your TV, be sure to turn off the power and unplug both units from the wall outlet before making any connections.

HDMI, the HDMI logo and High-Definition Multimedia Interface are trademarks or registered trademarks of HDMI licensing LLC.

B. Connecting an Audio Receiver

This player will down-mix Dolby Digital or DTS multi-channel audio to stereo audio for playback on the player's internal speakers or for output to a connected amplifier.

Listening on External Audio Equipment

1. Connect the player to the left/right Audio In jacks on the other equipment using the included AV cable.
2. Turn on your audio equipment and follow the instructions provided with it to select the AUDIO IN function.

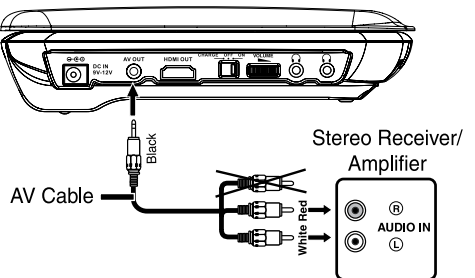

Note:

- Make sure to use the correct cable. Connecting the plugs incorrectly may cause lack of signal, or weak signal.

Connections

C. Using USB port

You can connect a USB flash drive (not included) to the USB port on the unit to play picture files. For operation of file playback on the USB flash drive, please refer to the section "Playing Picture Files".

Note:

- It is recommended that the product is turned OFF when you plug in a USB flash drive.
- It does not support USB hard disk mass storage devices, multi-card readers and other USB computer peripherals.
- It only supports USB flash drives (FAT32/16, max. capacity 32G bytes, max video bitrate is 7Mbps).
- Make sure your USB flash drive is FAT16/FAT32 file system. All other file systems will not be supported.

D. Using Headphones/Earphones

Turn down the volume before connecting the headphones/earphones. Slowly raise the volume with the headphones on until you reach your desired volume. When headphones are connected, the speaker is automatically disabled.

For your convenience, we've included two headphone jacks - allowing two Users to listen at the same time.

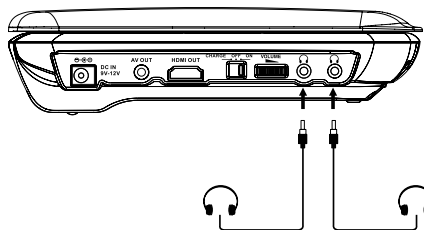

Headphones/Earphones
[1/8" (3.5mm) diameter plug]



Warning:

Excessive sound pressure from earphones and headphones can cause hearing loss. Avoid listening to sound at excessive levels which could be harmful to your ears.

E. Ethernet Jack - Connecting to a Home Network

This jack is currently not operational. However, a Product Software Upgrade (on www.RCAav.com) may be available that will enable you to activate the ethernet jack and use your player to support BD-Live operation.

If you've upgraded the Product Software to activate the ethernet jack, and you have a working home network with internet access:

1. Connect this jack to your Home Network Router using an ethernet cable.
2. Connect a USB Flash Drive (with 1GB or more free space on it) to the USB port on the front of the player (this is required for BD-Live operation).

Note:

- Do not connect a modular phone cable to the LAN jack.
- When plugging or unplugging the cable, hold the connector on the end of the cable. When unplugging, do not pull on the cable. Press down the lock tab and pull the connector out of the jack.
- Ensure your Home Network is operating correctly, ensure you have a connection to the Internet. Follow the instructions from your Internet Service Provider, or your Home Network's Router Manual on testing your Home Network's operation.

Mounting in a Vehicle

CAUTION:

1. Do not use this player case as a swing, car seat, or for any other purpose except to hold a player and accessories.
2. The player case is intended for viewing only from the rear seats. Do not install or use this product in the front seat of a vehicle.
3. To reduce the chance of injury in case of a collision or sudden stop:
 - Always keep player strapped securely inside case while vehicle is moving.
 - Always keep player case securely attached inside vehicle while the vehicle is moving.
4. Always position the plastic hooks and strap adjustment slider so that they do not touch the back of the head of the person in the front seat.

To Attach the Player Case to a Headrest (Images 1 & 2)

1. Insert the player into the case as shown right (1, 2, 3).
2. Unzip the main compartment that holds the player; locate the D rings at the top of the case (A).
3. Locate 2 straps with hooks on each end.
4. Hook one end of the each strap to the D rings at the top of the case.
5. Criss-cross the straps around the front of the headrest (B) and hook the straps to a second set of rings on the lower part of the case (C).
6. Tighten up the straps until the unit is secured. Connect the 12V car adapter as shown on the right (D).

Image 1

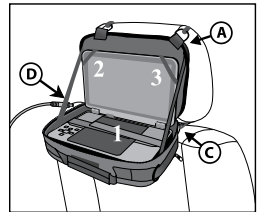
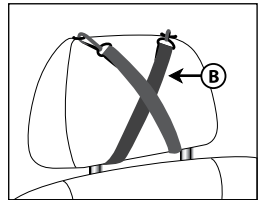

Image 2



Note: Before closing the bag, release the left and right elastic bands from the screen panel.

CAUTION

1. High temperature damages discs.
2. Do not store in closed cars.
3. Protect from direct sunlight.

Sound System

DTS2.0+Digital Out

DTS2.0+Digital Out denotes the dual ability to pass the DTS encoded digital bitstream to an external DTS decoder for playback as well as down-mix the digital surround soundtrack for playback in a 2-channel environment through analog outputs.

Manufactured under license under U.S. Patent #'s: 5,451,942; 5,956,674; 5,974,380; 5,978,762; 6,487,535 & other U.S. and worldwide patents issued & pending. DTS and the Symbol are registered trademarks, & DTS 2.0+Digital Out and the DTS logos are trademarks of DTS, Inc. Product includes software. ©DTS, Inc. All Rights Reserved.



Dolby TrueHD

Dolby TrueHD is a very high quality audio format that reproduces the studio master audio.

This unit allow audio to be decoded to a maximum of 5.1 ch of PCM audio and output from the HDMI terminal. Also, audio can be output with "Bitstream" to an AV amplifier that supports it.

Manufactured under license from Dolby Laboratories.

'Dolby' and the double-D symbol are trademarks of Dolby Laboratories.



Unit Operation

Turning on the Unit

1. Slide the CHARGE / OFF / ON switch on the player to the ON position.
2. The start-up picture will appear on the screens.
3. After use, slide the CHARGE / OFF / ON switch on the player to OFF.

Note:

- **If the CHARGE / OFF / ON switch is in ON position, but the product does not appear to be on, it's actually in STANDBY mode - you can turn it on by moving the switch to the OFF (middle) position, then back to ON position. You can also turn the product from STANDBY to ON using the remote control's  button.**
- **When the CHARGE / OFF / ON switch is in ON position you can use the remote control to put the product in STANDBY mode. The red light on the front of the product will illuminate when the product is in STANDBY mode.**
- **Please ensure the player is powered by the AC power adapter if you intend to use STANDBY mode.**

Playing a Blu-ray Disc or DVD

This owner's manual explains the basic instructions for operating this unit. Some discs are produced in a manner that allows specific or limited operation during playback. Therefore, this unit may not respond to all operating commands. THIS IS NOT A DEFECT. Please refer to the instructions accompanying the specific disc in question for

more information about the options available on that disc.

"⊗" may appear on the screen during operation.

A "⊗" means that the desired operation is not permitted by the unit or disc.

Playing a Blu-ray Disc or DVD

1. Slide the CHARGE/OFF/ON switch to the ON position.
See CUSTOMIZING THE DVD FUNCTION SETTINGS before proceeding to step 2.
2. Push to open the disc door.
3. Hold the disc by its edge and gently push it onto the spindle, with the label side facing the front, until you hear a "click".
4. Push the disc door gently to close it. It takes a short while for your unit to load the disc. After loading, for most discs, the unit will automatically take you to the main menu or start playing. If the unit does not automatically start playing the disc, press the ► PLAY button.

Pausing Playback (Still Mode)

Press the || (PAUSE) STEP button to pause. To resume normal playback, press the ► PLAY button. Each time you press the || (PAUSE) STEP button, the picture advances one frame on disc.

Stopping Playback

To stop playback, press the ■ STOP button. To resume playback, press the ► PLAY button. Depending on the disc, playback starts where it stopped or at the beginning of the disc.

If you press the ■ STOP button twice, the unit's memory will be cleared and pressing the ► PLAY button will reset the disc to the beginning.

Skipping to a Different Track

- Press the ◀◀ SKIP button to go back to previous titles/chapters/tracks.
- Press the ▶▶ SKIP button to advance titles/chapters/tracks.
- For an audio CD, use the number buttons on the remote control to go directly to the desired track number.

Zooming into an image

While a disc is playing, press the ZOOM button to enlarge the image in several levels.

- While an image is zoomed, you can use the ▲, ▼, ◀ or ► CURSOR button to shift the view and display the part you want.
- To return to normal view, press the ZOOM button repeatedly until "OFF" shows. The screen will return to normal.
- When you reach the edge of the image, the display will not shift anymore in the direction.

Fast Forward / Fast Reverse

1. Press the ◀◀ or ▶▶ button when a disc is playing.
 - The disc begins a fast scan at two times normal (x2) speed.
 - Each time the ◀◀ or ▶▶ button is pressed, the speed of the fast scan changes.

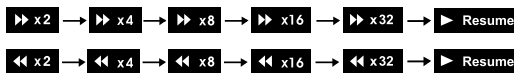

2. Press the ► PLAY button when you have reached the desired point to resume playback at normal speed.

Audio Selection

On some discs, the sound is recorded in two or more formats. Follow the directions below to select the type of playback.

1. While a disc is playing, press the AUDIO button to show the current audio format number.
2. Press the AUDIO button repeatedly to select the desired audio format.

1 OF 4: ENGLISH DTS.HD 5.1 CH

Note:

- If only one audio format is recorded, the number does not change.
- About two seconds later, playback continues in the new audio format.

Subtitle Selection

1. While a disc is playing, press the SUBTITLE button to display the current language setting.
2. Press the SUBTITLE button repeatedly to select the desired subtitle language.

1 OF 4: ENGLISH

Note:

- Some discs are set to display subtitles automatically, and you cannot turn them off even if you set the subtitle function to off.
- During some scenes, the subtitles may not appear immediately after you select your desired scene.
- The number of subtitle languages recorded differs depending on the disc. If only one language is recorded, the language does not change.
- This function can only be used for discs on which subtitles have been recorded in multiple languages.
- Some discs allow you to change subtitles using the disc menu only. If this is the case, press the MENU button and choose the appropriate subtitle on the disc menu.

Angle Selection

Some discs contain scenes that have been shot from a number of different angles. For these discs, the same scene can be viewed from each of these different angles.

1. While you are playing a disc with different angles recorded, press the ANGLE button to view the number of current angles available.
2. Press the ANGLE button repeatedly to change the scene to the next angle in those recorded.
 - About two seconds later, playback continues from the new angle selected.
 - If no button is pressed within 10 seconds, playback continues without changing the current angle.

Note:

- This function can only be used for discs on which scenes shot from multiple angles have been recorded.
- If only one angle is recorded, " ⊗ " is displayed.

Using the PiP (Picture-in-picture) mode

Some Blu-ray Discs support picture-in-picture (PiP) mode. In PiP mode, the primary video is displayed on the full screen, and the secondary video is displayed in a small window.

Primary video

Secondary video



- Press PiP button to turn PiP mode on or off.
- Press AUDIO or SUBTITLE button to turn the audio/subtitle for the video in the PiP window on or off. Then use cursor buttons and OK button to select your preferred options.

Note:

- The available options of Audio vary from different disc format.
- PiP Subtitle is not available for all discs. It only applies to Blu-ray discs that supports picture-in-picture features.

Using a Disc Pop Up Menu

1. During Blu-ray or DVD playback, press POP UP button, the Blu-ray popup menu or the title menu of DVD disc opens.
2. Press the cursor buttons to select an option, then press OK button.

Displaying Disc Information

- Press INFO button, your unit displays information about the Disc, such as type of disc, current elapsed time in title, total number of chapters.
- Press INFO button again to exit.

ENGLISH DTS-HD 5.1 (1/4) | H264 | ENGLISH (1/8) | 1920 x 1080 | ANGLE 1/1

TITLE 1/199 | CHAPTER 3/16 | 00:17:56 | 01:28:26

Note:

The information displayed for discs other than Blu-ray Discs will be different.

Using the Picture Menu

Press the PICTURE button, you may change the Brightness, Contrast, Backlight and Screen.

- Use the ▲ or ▼ button to highlight your selection, then use the ◀ or ▶ to change the settings.
- Your setting will be changed immediately.

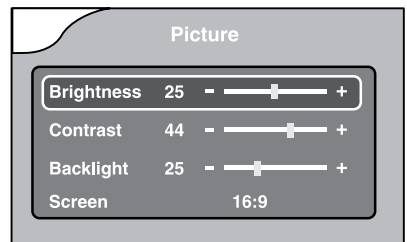

Locating a Desired Section

Locating a specific title

If a Blu-ray Disc or DVD contains title numbers, you can locate a specific title by directly selecting its title number.

1. Press the GOTO button.
2. Press the ► button to highlight title number, press the corresponding number buttons (0-9) for the title you want, then press the OK button to confirm.
3. Playback starts from the selected title.

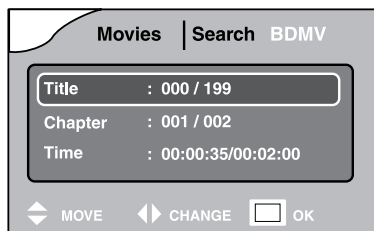

Title : ___ / 199

Locating a specific chapter

If you know the chapter number for the chapter that you want to play, you can locate it by directly selecting that number.

1. Press the GOTO button.
2. Press ▼ to select Chapter, press the ► button to highlight chapter number, press the corresponding number buttons (0-9) for the chapter you want, then press the OK button to confirm.
3. Playback starts from the selected chapter.

Chapter : ___ / 002

Locating a specific time

You can move to a specific location by entering its corresponding time (hours, minutes, seconds).

1. Press the GOTO button.
2. Press ▼ to select Time, press the ► button to highlight time, enter the corresponding number buttons (0-9) for the setting point you want, then press the OK button to confirm.
3. Playback starts from the selected section.

Time : __ : __ : __ /00:02:00

Note:

- Some discs may not respond to this process.
- Some scenes may not be located as precisely as you specified.
- This method for accessing specific locations is available only within the current title of the disc.

Playing Picture Files

This unit can play picture files stored on Blu-ray Disc (BD), USB flash drives, CD-R/CD-RW, DVD+R/-R or DVD+RW/-RW discs.

Playing Picture Files from a disc or USB drive.

1. Load the disc containing JPG files or insert the USB drive containing JPG files.
2. A selection menu will appear on the screen.
3. While viewing a JPG, you can press ENTER button to access viewing options such as ROTATE, SLIDESHOW SPEED, and TRANSITION EFFECTS.

Note:

- For playing files on USB flash drive, you should plug in the USB flash drive when the unit is in OFF mode.
- You can press the ■ PAUSE button to interrupt playback, and press the ► PLAY button to resume playback.

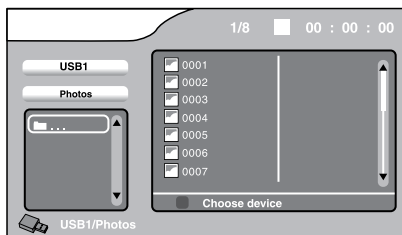

Repeat Playback

You can play a specific title or chapter repeatedly. (Chapter repeat, title repeat, A-B repeat)

Repeating a chapter (Blu-ray Disc or DVD)

You can play the same chapter repeatedly.

1. While the disc is playing, press the REPEAT DISC button until the **REPEAT CHAPTER** indicator displays on the screen. The current chapter is played repeatedly.

Repeating a title

You can play the same title repeatedly.

2. While the disc is playing, press the REPEAT DISC button until the **REPEAT TITLE** indicator displays on the screen. The current title is played repeatedly.

To resume normal playback

3. While the disc is playing, press the REPEAT DISC button until the **REPEAT OFF** indicator displays on the screen.

Repeating a single track (CD)

You can play a single track or an entire disc repeatedly.

You can play the same track repeatedly.

1. While the disc is playing, press the REPEAT DISC button until the **REPEAT ONE** indicator displays on the screen. The current track is played repeatedly.

Repeating an entire disc

2. While the disc is playing, press the REPEAT DISC button until the **REPEAT ALL** indicator displays on the screen. The entire disc is played repeatedly.

To resume normal playback

3. Press the REPEAT DISC button until the **REPEAT OFF** indicator displays on the screen.

Repeating a specific section (Blu-ray Disc/DVD/CD)

You can play a specific section repeatedly.

1. While the disc is playing, press the REPEAT A-B button at the beginning of the section (**REPEAT A** is displayed) you want to play repeatedly.
2. Press the REPEAT A-B button again at the end of the section (**REPEAT AB** is displayed) you want to play repeatedly.
3. The unit will immediately begin replaying your selection.

To resume normal playback

4. While the disc is playing, press the REPEAT A-B button until the **REPEAT OFF** indicator displays on the screen.

Note:

- A-B repeat can only be used within the same title. If the start and end of the section to be repeated are in different titles, A-B repeat is cancelled.
- The A-B repeat function does not operate in scenes where different camera angles are recorded.

Customizing the Function Settings

Language Setup

1. In STOP mode, press the SETUP button. Language is highlighted.
2. Use the ► button to move the highlight bar to the right, press the ▲ or ▼ button to select Player Menu, Subtitles, Disc Menu and Audio, press the OK button to select.
3. Use the ▲ or ▼ button to select your preferred language, then press the OK button to confirm.
4. Press the ◀ button to go back to the previous menu. Repeat steps 2 and 3 to adjust other options.
5. To exit the SETUP MENU and return to the normal screen, press the EXIT or SETUP button.

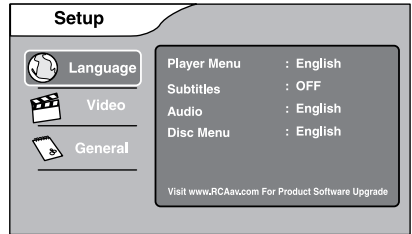

Note:

- Some discs may not play in the audio language selected. A prior language may be programmed on the disc.
- Some discs may be set to display subtitles in a language other than the one selected. A prior subtitle language may be programmed on the disc.
- Some discs allow you to change subtitle selections via the disc menu only. If this is the case, press the MENU button and choose the appropriate subtitle from the selection on the disc menu.
- Some discs may not included your pre-selected language. In this case, the player automatically displays disc menus consistent with the disc's initial language setting.

Video Setup

1. In STOP mode, press the SETUP button. Press the ▼ button to select Video.
2. Use the ► button to move the highlight bar to the right, press the ▲ or ▼ button to select TV Shape, View Mode and HDMI Resolution, press the OK button to select.
3. Use the ▲ or ▼ button to select your settings, then press the OK button to confirm.
4. Press the ◀ button to go back to the previous menu. Repeat steps 2 and 3 to adjust other options.
5. To exit the SETUP MENU and return to the normal screen, press the EXIT or SETUP button.

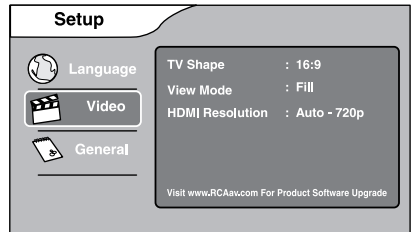

TV Shape

Depending on the format of the Blu-ray Disc or DVD, you can choose the picture format (aspect ratio) best suited to the format of your TV screen:

4:3

- When wide-screen video is played, this mode clips the right and left sides of the image so that it can be viewed on a conventional screen.
- Some wide-screen discs that do not permit Pan Scan mode playback are automatically played in letterbox mode.
- When wide-screen video is played in this mode on a conventional Analog TV, black bands appear at the top and bottom of the screen.

16:9

- This is the correct mode for playing wide-screen videos on on a wide-screen TV (most modern Digital TV's).

Note:

- The displayable picture size is determined by the DVD disc. Therefore the playback picture of some discs may not conform to the picture size you select.
- When you play discs recorded in the 4:3 aspect ratio, the playback picture will always appear in the 4:3 aspect ratio regardless of the TV TYPE setting.

View Mode

16:9 Wide, 16:9 Pillarbox, 4:3 Pan and Scan, and 4:3 Letterbox are available for your choice.

Note: Depending on the disc, you may not be able to view the mode as selected.

HDMI Resolution

To select the HDMI resolution to match the capabilities of your TV.

Note: HDMI resolution can be only selected if the HDMI cable is connected to a TV.

General Setup

1. In STOP mode, press the SETUP button. Press the ▼ button to select General.
2. Use the ► button to move the highlight bar to the right, use the ▲ or ▼ button to select Screen Saver, Software Update, Use Default Settings and BD-Data Storage, press the OK button to select.
3. Use the ▲ or ▼ button to select your settings, then press the OK button to confirm.
4. Press the ◀ button to go back to the previous menu. Repeat steps 2 and 3 to adjust other options.
5. To exit the SETUP MENU and return to the normal screen, press the EXIT or SETUP button.

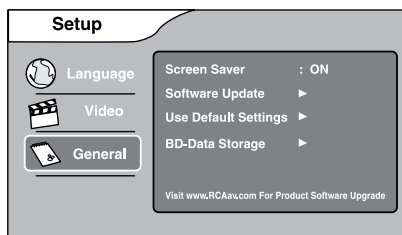

Screen Saver

To turn on or off the screen saver (screen protection to prevent image burn).

Note: When you leave the unit in stop mode for approximately 5 minutes, the screen saver of the unit automatically appears if you set the Screen Saver to On mode. To turn off the screen saver, press the PLAY button.

Software Update

For future Product Software Upgrades - please visit www.RCAav.com for information on updates.

Use Default Settings

Restores your player to the original factory settings. The unit will exit the default setting menu automatically and re-load the disc in the disc tray.

Note: It will take 3-5 seconds to reset the player to the factory default.

BD-Data Storage

The available storage space is displayed next to BD-Data Storage.

Maintenance

Cleaning the Disc

A defective or soiled disc inserted into the unit can cause sound to drop out during playback. Handle the disc by holding its inner and outer edges.

- Do NOT touch the surface of the unlabeled side of the disc.
- Do NOT stick paper or tape on the surface.
- Do NOT expose the disc to direct sunlight or excessive heat.
- Clean the disc before playback. Wipe the disc from the center outward with a cleaning cloth.
- NEVER use solvents such as benzene or alcohol to clean the disc.
- Do NOT use irregular shaped discs (example: heart shaped, octagonal, etc.). They may cause malfunctions.



Cleaning the Unit

- Be sure to turn the unit off and disconnect the power source before maintaining the unit.
- Wipe the unit with a dry soft cloth. If the surfaces are extremely dirty, wipe clean with a cloth that has been dipped in a weak soap-and-water solution and wrung out thoroughly. Then wipe with a dry cloth.
- Never use alcohol, benzene, thinner, cleaning fluid or other chemicals. Do NOT use compressed air to remove dust.

Important Note

- Before transporting the unit, remove any disc from the disc compartment.

Note:

- If the CHARGE / OFF / ON switch is in ON position, but the product does not appear to be on, it's actually in STANDBY mode - you can turn it on by moving the switch to the OFF (middle) position, then back to ON position. You can also turn the product from STANDBY to ON using the remote control's  button.
- When the CHARGE / OFF / ON switch is in ON position you can use the remote control to put the product in STANDBY mode. The red light on the front of the product will illuminate when the product is in STANDBY mode.
- Please ensure the player is powered by the AC power adapter if you intend to use STANDBY mode.

Need more help?

Please visit online help at www.RCAav.com

Troubleshooting Guide

SYMPTOM	CAUSE (AND REMEDY)
No power	<ul style="list-style-type: none">• Ensure the power adapter is connected.• Make sure that the unit is turned on.
Power switch is in ON position, but the product isn't ON.	<ul style="list-style-type: none">• The product is in STANDBY mode - turn switch to OFF (middle) position, then back to ON position.
The remote control does not function.	<ul style="list-style-type: none">• Remove any obstacles between the remote and the unit.• Use the remote near the unit.• Point the remote at the remote sensor on the unit.• Replace the battery in the remote with new one.• Make sure plastic sheet has been removed from battery section.
Very little or no sound is coming from a DVD.	<ul style="list-style-type: none">• The volume control is located on the side of the unit - please try adjusting this.• Make sure that you select ON mode.• Make sure the unit is not paused. Press the ► PLAY button.• Make sure the unit is not in fast-forward or fast-reverse mode. Press the ► PLAY button.• Make sure the AUDIO/VIDEO input/output connections are correct.• The unit has overheated. Shut it off for 30 minutes to allow it to cool down.
No picture.	<ul style="list-style-type: none">• The region number of the disc doesn't match the region number of this unit. 
The picture is not clear.	<ul style="list-style-type: none">• The disc is dirty. Gently clean the disc.• The disc is scratched.
Loud hum or noise is heard.	<ul style="list-style-type: none">• The plugs and jacks are dirty. Wipe them with a cloth slightly moistened with alcohol.• Clean the disc.
Blu-ray Disc or DVD does not play.	<ul style="list-style-type: none">• Make sure that the disc has the correct region code.• There is no disc inside the unit ("No Disc" appears on the screen).• Insert the disc correctly with the graphics facing up.• Clean the disc.• A non-NTSC disc has been inserted, or the disc region number does not match the region number of the unit.• Condensation may have formed inside the unit due to a sudden change in temperature. Wait about an hour for it to clear and try again.
Picture-in-Picture (PiP) does not work on a Blu-ray Disc	<ul style="list-style-type: none">• Make sure that disc supports PiP mode.

Specifications and external appearance are subject to change without notice.

Limited Warranty

AVC MULTIMEDIA ("AVC") makes the following limited warranty. This limited warranty extends to the original consumer purchaser and is limited to non-commercial use of the product.

One Year Parts & Labor Warranty

AVC products purchased in the United States are warranted to be free from defects in materials or workmanship for a period of one year from the date of their original retail purchase. If the unit fails to conform to this warranty, we will service the product using new or refurbished parts and products, at **AVC's** sole discretion.

During a period of one year from the effective warranty date, **AVC** will provide, when needed, service labor to repair a manufacturing defect at its designated Service Center. To obtain warranty service in the United States, you must first call our **Customer Support Center at 1-800-506-5746 or 1-877-252-6873, during the hours listed in the box below.** The determination of service will be made by AVC Customer Support. **PLEASE DO NOT RETURN YOUR UNIT TO AVC WITHOUT PRIOR AUTHORIZATION.** New or remanufactured replacements for defective parts or products will be used for repairs by AVC at its designated Service Center for one year from the effective warranty date. Such replacement parts or products are warranted for an additional one year from the date of repair or replacement. The Customer will be required to ship the unit to the Service Center indicated at the time Customer Support is contacted to make the necessary repairs. The customer is responsible for all transportation charges to the service facility.

Packaging and Shipping Instruction

When you send the product to the **AVC** service facility you must use the original carton box and packing material or an equivalent as designated by **AVC.**

LIMITED WARRANTY

Your Responsibility

- (1) You must retain the original sale receipt to provide proof of purchase.
- (2) These warranties are effective only if the product is purchased and operated in the U.S.A. or Canada.
- (3) Warranties extend only to defects in material or workmanship, and do not extend to any product or parts which have been lost or discarded, or damage to product or parts caused by misuse, accident, improper operation or maintenance, or use in violation of instructions provided with the product, or to product which has been altered or modified without authorization of **AVC,** or to products or parts thereof which have had the serial number removed or changed.

Out of Warranty

In the event your product requires repair after the limited warranty period has expired, please contact our Customer Support Center at **1-800-506-5746, 1-877-252-6873 or www.RCAav.com**

Hours: Monday–Thursday: 9am–7pm, Friday: 9am–5pm, Saturday: 9am–NOON Eastern time.

Important: You are responsible for any transportation, shipping or insurance relative to the return of product to our Product Returns Center.

All warranties implied by state law, including the implied warranties of merchantability and fitness for a particular purpose, are expressly limited to the duration of the limited warranties set forth above. With the exception of any warranties implied by state law as hereby limited, the foregoing warranty is exclusive and in lieu of all other warranties, guarantees, agreements and similar obligations of manufacturer or seller with respect to the repair or replacement of any parts. In no event shall **AVC** be liable for consequential or incidental damages.

No person, agent, distributor, dealer or company is authorized to change, modify or extend the terms of these warranties in any manner whatsoever. The time within action must be commenced to enforce any obligation of **AVC** arising under the warranty or under any statute, or law of the United States or any state thereof, is hereby limited to one year from the date of purchase. This limitation does not apply to implied warranties arising under state law.

This warranty gives you specific legal rights and you may also have other rights, which may vary, from state to state. Some states do not allow limitation on how long an implied warranty lasts, when an action may be brought, or the exclusion or limitation of incidental or consequential damages, so the above provisions may not apply to you.

For more information on other products and services, please visit our web site at **www.RCAav.com**

Important: Also keep your "Bill of Sale" as proof of purchase.

Model no. Product name.....
 Type of set
 Serial no. Invoice no.
 Date purchased Dealer name.....

FOR SERVICE AND REPAIR, PLEASE VISIT **www.RCAav.com**